



Installation Guide for Elevate Industrial Gutters

(Box, Offset, and Chamfer)

Elevate
26 Century Blvd., Suite 205
Nashville, TN 37214
Contact your local Elevate representative.

APPROVALS: Contact manufacturer for verification of test report data on your project

ANSI/SPRI-GT-1
TESTED

MIAMI-DADE COUNTY
APPROVED

Installation Guide for Elevate Industrial Gutters

ANSI/SPRI-GT-1 TEST PRESSURES UP TO 136 PSF (VERTICAL), AND 223 PSF (HORIZONTAL)
CONTACT US FOR APPROPRIATE RECOMMENDATIONS NEEDED TO MEET/EXCEED ANSI/SPRI-GT-1 DESIGN CRITERIA

FM
Approved

Box Version

(SHOWN THROUGHOUT INSTALL GUIDE)

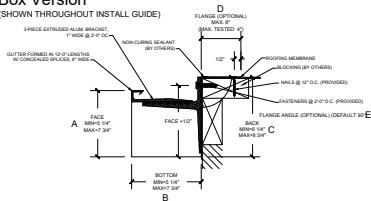

BOTTOM SIZES ARE PROVIDED IN 1/2" INCREMENTS (e.g. 5 1/4", 5 3/4", 6 1/4",)
FOR MASONRY APPLICATIONS, PLEASE CONTACT US.

Offset Version

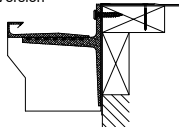

Chamfer Version

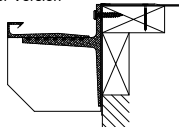

NOTES:

#1 - Isolate all metal parts from ACQ treated wood or other galvanically incompatible material with appropriate membrane material.
#2 - Appliance attachments, such as lightning rods, signs, or antennae that penetrate the edge system, induce a galvanic reaction, or otherwise compromise the effectiveness of the roof edge system, shall be eliminated or isolated to prevent problems per ANSI/SPRI/IED-1. Lightning protection systems for example must not be directly affixed to the product provided by the Manufacturer. Consult Manufacturer for alternative attachment suggestions.

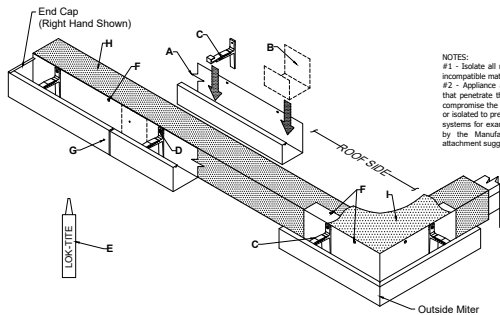

A. Formed Gutter

12-ft. Lengths

B. Concealed Joint Splice

6-in. Lengths

C. Extruded Alum. Bracket

1-in. Length @ 24-in. OC

D. Universal Fastener

at All Bracket Locations
(Included & Required)

E. Lok-Tite

at All Brackets
(Included & Required)

F. Nails

(Included & Required)

G. Aluminum Pop-Rivet

(Included & Required)

H. Base Ply Membrane

(By Others)

I. Strip-In Ply

(By Installer)

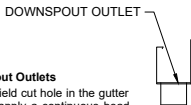

STEP 1: Installing Downspout Outlets

Determine outlet locations and field cut hole in the gutter bottom. Insert outlet into hole, apply a continuous bead of non-curing sealant to flange and fasten with (2) pop rivets in each flange from outside.

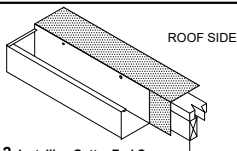

STEP 2: Installing Gutter End Caps

Locate the end caps for the appropriate locations. Secure to the roof edge using the nails (provided) in every other pre-punched hole. If optional roof flange is included install with nails in all holes in roof flange.

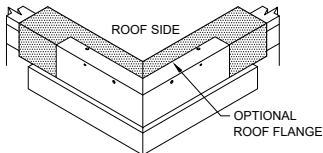

STEP 3: Installing Gutter Miters

Locate the miters for the appropriate locations. Secure to the roof edge using the nails (provided) in every other pre-punched holes. If optional roof flange is included install with nails in all holes in roof flange.

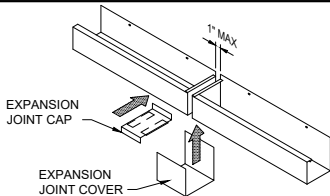

STEP 4: Installing Expansion Joints (If Required)

Install expansion joint in location as specified on roof plan(s). An expansion joint will consist of (2) pre-fabricated end caps, (1) expansion joint cap and (1) expansion joint cover. Gap the end caps at 1" max. Slide the joint cover onto the gutter, then pop rivet the joint cover in the same locations as shown in FIGURE 2. Place the joint cap over the end cap lips and center the joint cap over the gap, secure in place using the nails (provided).

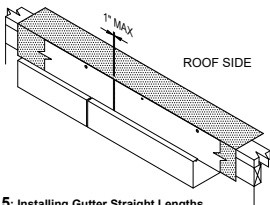

STEP 5: Installing Gutter Straight Lengths

Begin from the end caps/miters working inward to the center. **Allow 1/4" gap between gutter sections for thermal expansion.** Review lengths of all straight pieces prior to cutting to avoid creating relatively short sections of cap adjacent to full length section.

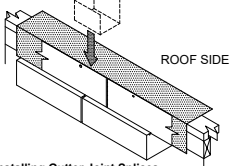
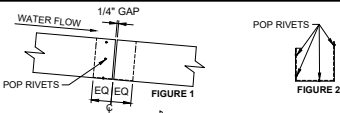

STEP 6: Installing Gutter Joint Splices

Locate the joint splice for the appropriate gutter. Apply a continuous bead of non-curing sealant to both sides of the joint. Slide the joint splice down into the gutter. Secure the joint splice in place by pop riveting it on the high side of the joint (FIGURE 1) on the 3 surfaces as shown in FIGURE 2. There must be a joint splice at every joint.

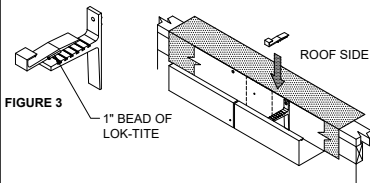

STEP 7: Installing Gutter Brackets

Install the bracket base first, secure it in place using the screw (provided). Then hook the top part of the bracket on the face lip of the gutter. Slide the top onto the base by 1/4" (MAX), then apply a 1" (MIN) continuous bead of Lok-Tite (provided) as shown in FIGURE 3. Then continue sliding the top onto the base, until they are aligned. The brackets should be installed at the pre-punched hole adjacent to the fasteners previously installed (24" OC max).