

FiberTite 200 Fascia

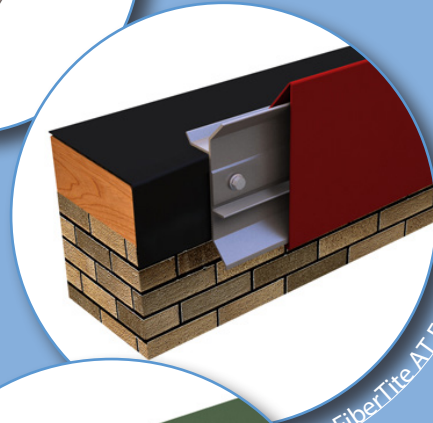

FiberTite AT Fascia

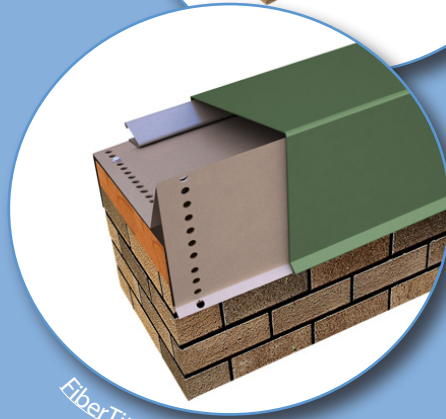

FiberTite Coping

Roof Edge Systems

www.metalera.com/fibertite

FiberTite Roof Edges

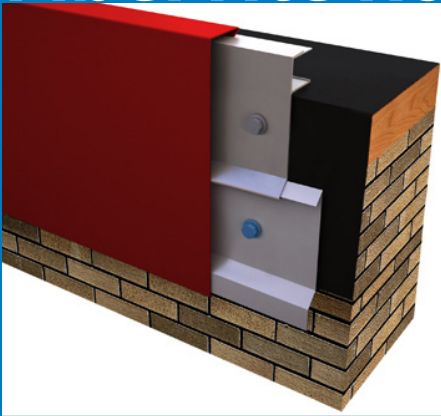

FiberTite's line of roof edge systems is engineered and tested to withstand the harshest of conditions and is specifically designed to compliment the FiberTite line of roof membranes. The roof edge is the most vulnerable part of the roof because it is subject to wind forces that greatly impact the integrity of the entire roof system. FiberTite roof edge systems provides a full system warranty that covers both the membrane and the roof edge.

FiberTite AT Extended Fascia

System Benefits

Overview

- Full system is covered under one warranty
- Custom & radius profiles available; can accommodate multiple nailers
- Slotted fastening holes for proper thermal movement & correct fastener placement
- Available in standard & custom finishes

New

- FiberTite AT Canted Fascia
- FiberTite AT HG Fascia
- Express Colors & Lead Times

Installation Benefits

- Non-penetrating design eliminates stripping in or heat-welding, typical of other designs
- Pre-fabricated miters & accessories ensure a proper fit & save time & labor by eliminating field fabrication
- 12' lengths
- No unsightly cover plates
- Full snap on design for easy installation
- Arrives at the job site with all fasteners, splice plates and drivers included (sealant by others)

Testing

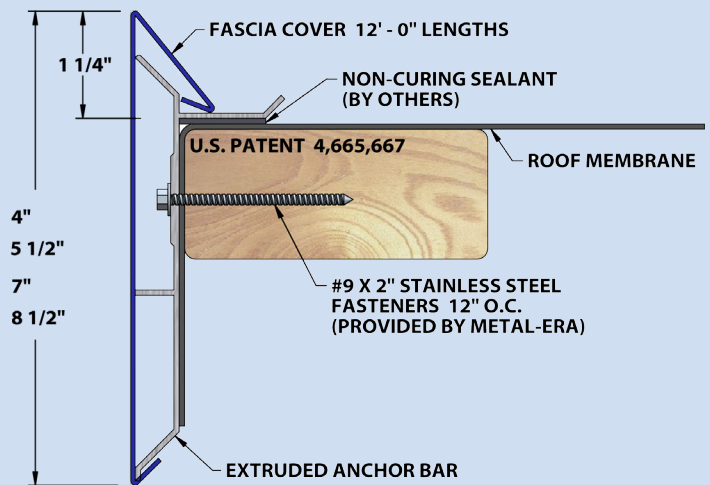

FiberTite AT Fascia

Fully Adhered or Mechanically Attached Single-Ply Version
24 ga. & .040" fascia cover

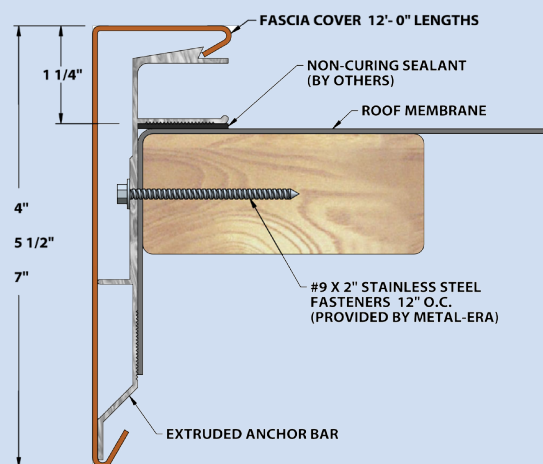

FiberTite AT HG Fascia

Fully Adhered or Mechanically Attached Single-Ply Version
.050" & .063" fascia cover



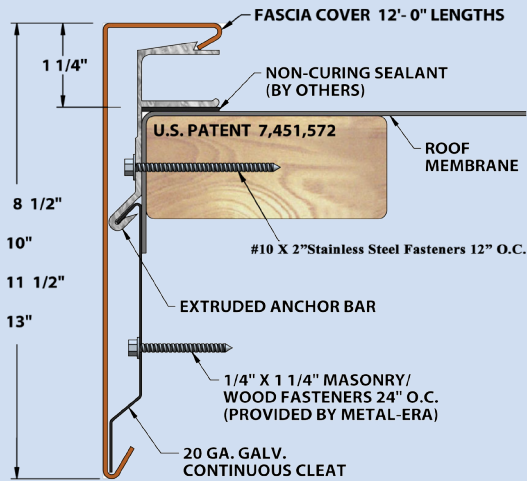

FiberTite AT Extended Fascia
Fully Adhered or Mechanically Attached Single-Ply Version
.050" & .063" fascia cover

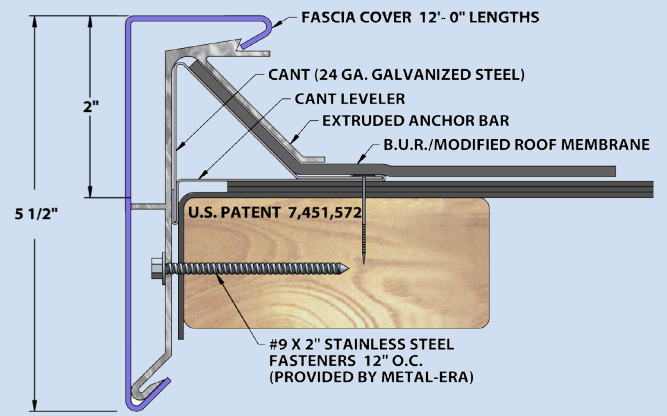

FiberTite AT Canted Fascia
Existing Cant & Galvanized Waterdam (shown) Versions
.050" & .063" fascia cover

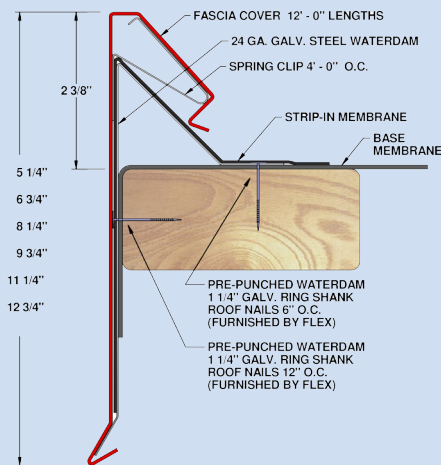

FiberTite 200 Fascia
Fully Adhered or Mechanically Attached Single-Ply (Shown)
& Stone Ballast Versions
24 ga., .040", .050", .063" fascia cover

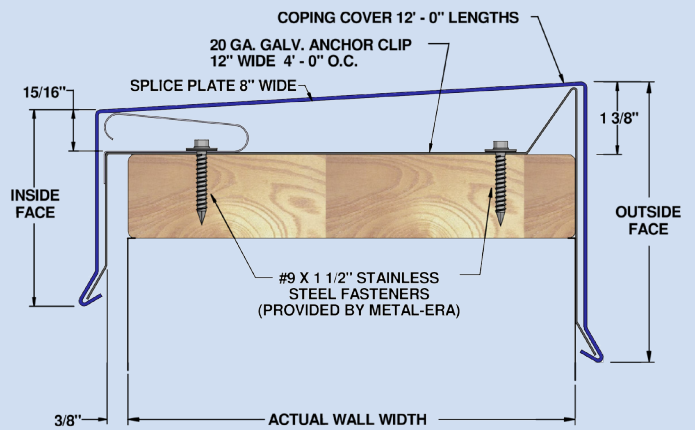

FiberTite Coping
Tapered, Flat or Existing Versions
24ga., .040", .050", .063" coping cover



Paxton Elementary School
Middle Paxton, PA

Materials & Finishes

Express Colors –

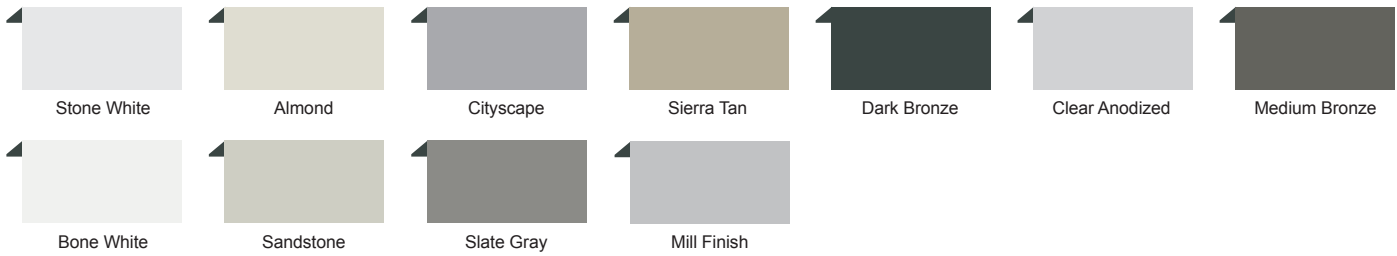

Standard Colors –

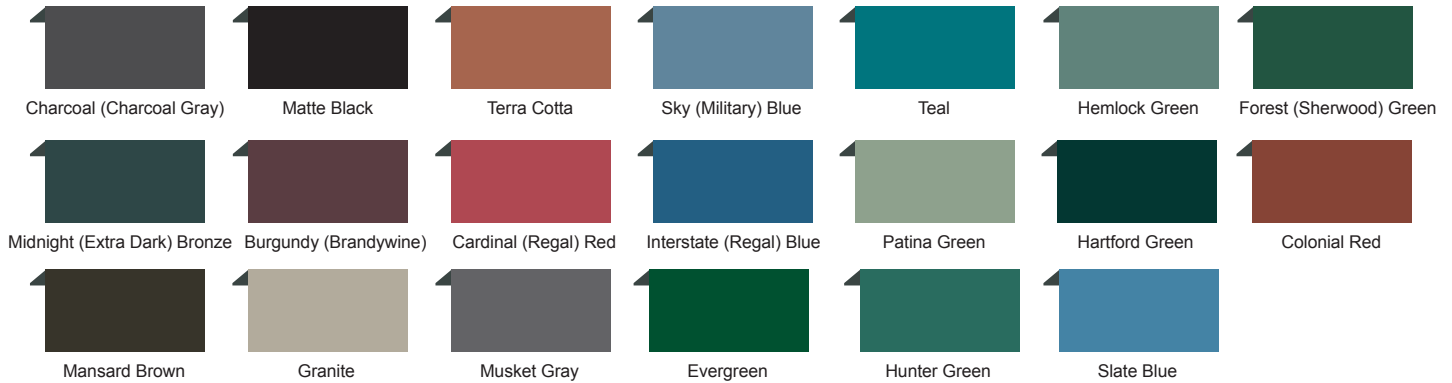

Premium Colors –

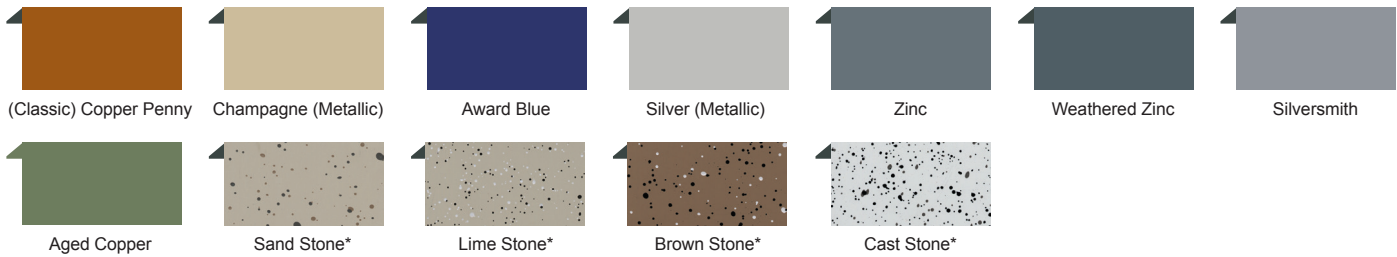

*Post Painted

Protective film must be removed immediately. Please note this chart is only a representation of color options. Color matches should only be made with actual samples. Kynar 500® is a registered trademark belonging to Arkema Inc. Please call 800-558-2162 for actual metal samples.

FiberTite also offers standard coil anodized finishes in clear, medium bronze, dark bronze and black. In addition to our standard finishes, FiberTite can provide custom color, postcoated Kynar paint finishes and batch anodized finishes on all mill aluminum gauges listed.

IMPORTANT NOTE: Due to shade variations in the anodizing process, it is recommended that the contractor work with the architect or building owner to sort and install products according to the owner's preference. FiberTite offers no warranty to anodized finishes and will not be held responsible for shade variations inherent to the anodizing process.



**INTELLIGENT
ROOFING SOLUTIONS**

1600 Airport Road
Waukesha, WI 53188
p: 888-666-4369
f: 800-770-3334

metalera.com/fibertite