

COUNTER-FLASH 2 PC COUNTERFLASHING

REGLET VERSION

INSTALLATION INSTRUCTIONS

STEP 1 - REGLET RECEIVER

INSTALL REGLET RECEIVER INTO 1" DEEP SAWCUT OR MORTAR JOINT. SAWCUT SHALL BE CUT TRUE AND LEVEL A MINIMUM OF 7" ABOVE THE HIGH POINT OF THE CANT STRIP (IF USED). INSTALL FROM RIGHT TO LEFT. LAP ENDS OF REGLET 3" AT FACTORY NOTCHED END.

NOTE: REMOVE PROTECTIVE FILM IMMEDIATELY.

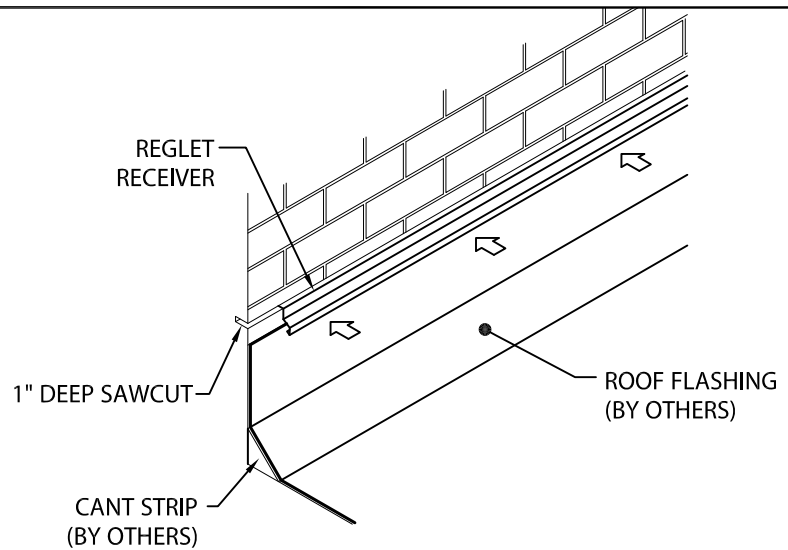

STEP 2 - COUNTERFLASHING

PRIOR TO INSTALLING COUNTERFLASHING, REMOVE PROTECTIVE FILM. HOOK COUNTERFLASHING ONTO RECEIVER AS SHOWN IN FIG. A. ROTATE DOWNWARD INTO PLACE (FIG. B). STAGGER REGLET RECEIVER AND COUNTERFLASHING JOINTS ACCORDINGLY.

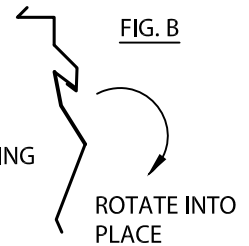
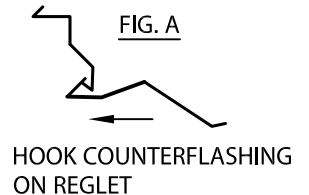
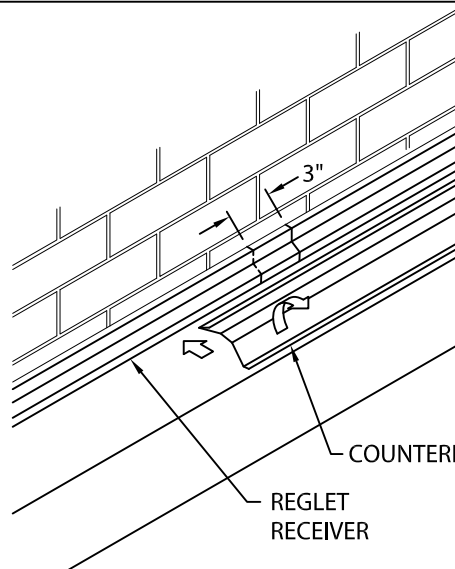

STEP 3 - COUNTERFLASHING

REMOVE PROTECTIVE FILM. HOOK COUNTERFLASHING ONTO RECEIVER AS SHOWN IN FIG. C. SLIDE COUNTERFLASHING 3" AT LAP JOINT OVER PREVIOUSLY INSTALLED PIECE. ROTATE DOWNWARD INTO PLACE AS SHOWN IN STEP 2.

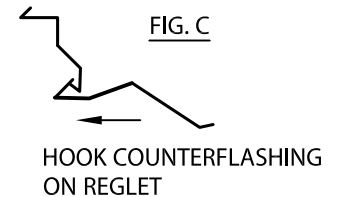
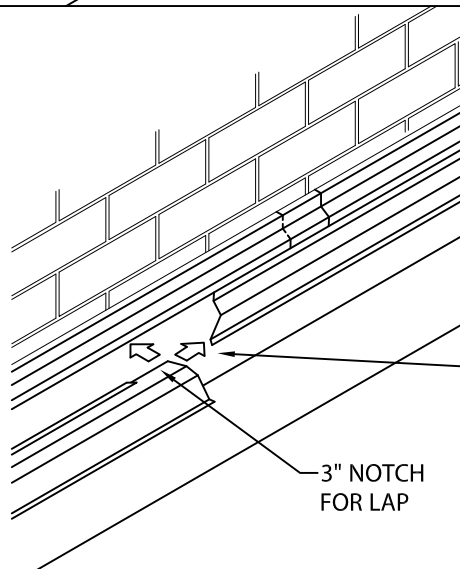

AFTER HOOKING, SLIDE COUNTERFLASHING OVER INSTALLED PIECE 3" AT LAP JOINT AND ROTATE INTO PLACE

COUNTER-FLASH 2 PC COUNTERFLASHING

REGLET VERSION

INSTALLATION INSTRUCTIONS

HIGH GRADE ARCHITECTURAL
SEALANT (BY OTHERS)

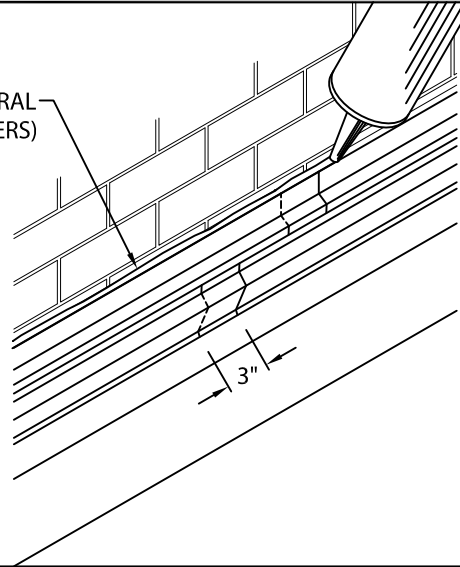

STEP 4 - COMPLETION
APPLY A CONTINUOUS BEAD OF HIGH
GRADE ARCHITECTURAL SEALANT IN
CAULK CUP OF REGLET TO COMPLETE
INSTALLATION.

TYPICAL INSTALLATION

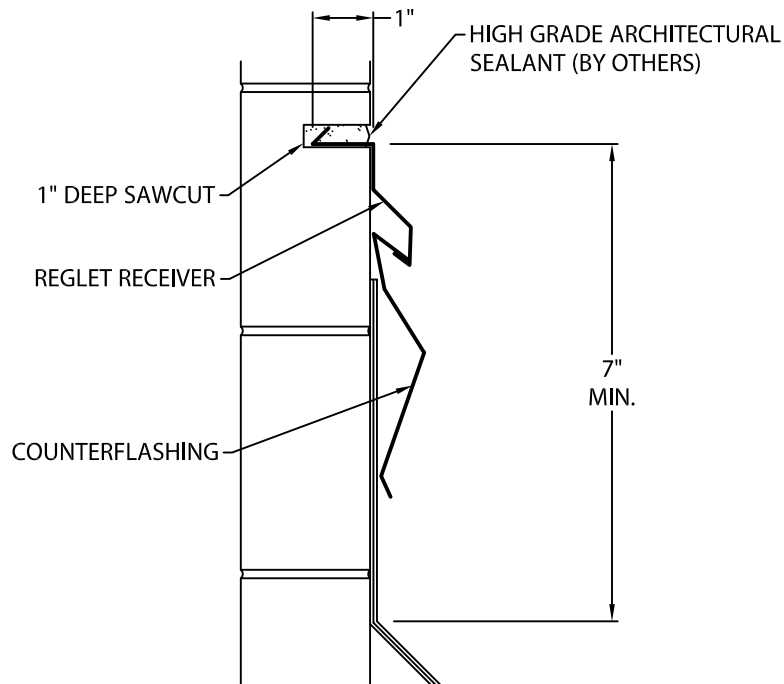

COUNTER-FLASH 2 PC

REGLET VERSION

INSTALLATION INSTRUCTIONS

PASO 1 - REGLETA RECEPTORA

INSTALE LA REGLETA RECEPTORA EN EL CORTE DE SIERRA DE 1" (25.4 mm) DE PROFUNDIDAD O UNIÓN DE MORTERO. EL CORTE DEBE HACERSE RECTO Y NIVELADO A UN MÍNIMO DE 7" (177.8 mm) POR ARRIBA DEL PUNTOALTO DE LA FAJA DE CANTO (SI SE UTILIZA). INSTALE DESDE LA DERECHA A LA IZQUIERDA SOLAPE LOS EXTREMOS DE LA REGLETA 3" (76.2 mm) EN EL EXTREMO MARCADO CON MUESCA DE FÁBRICA. QUITE EL PLÁSTICO PROTECTOR INMEDIATAMENTE.

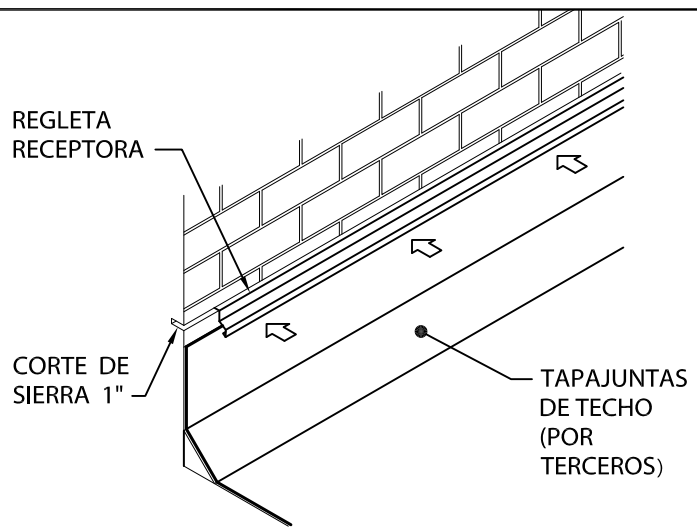

PASO 2

ANTES DE INSTALAR LA CONTRACHAPA, QUITE EL PLÁSTICO PROTECTOR. ENGANCHE LA CONTRACHAPA AL RECEPTOR COMO SE MUESTRA EN LA FIG. A. GIRE HACE ABAJO HASTA QUE QUEDE SUJETADO (FIG. B). ASIGURESE QUE LAS JUNTAS DE LOS RECEPTORES Y DE LAS JUNTAS DE LAS CONTRACHAPAS NO SE ALINEAN.

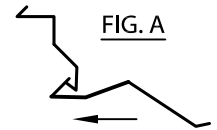
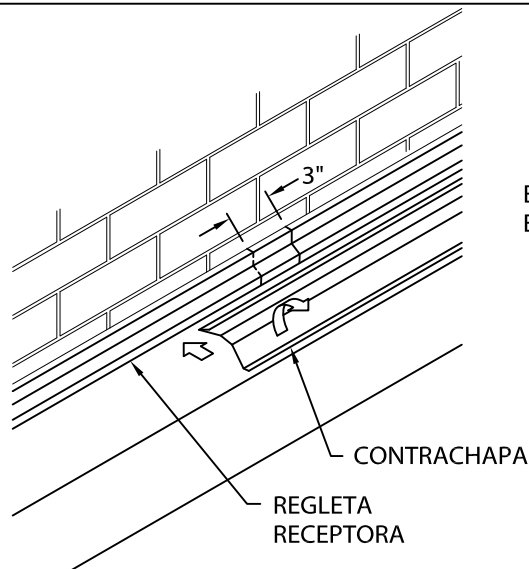

ENGANCHE CONTRACHAPA EN LA REGLETA



GIRE HASTA QUE QUEDE SUJETADO

PASO 3 - CONTRACHAPA

QUITTE EL PLÁSTICO PROTECTOR. ENGANCHE CONTRACHAPA EN LA REGLETA RECEPTORA COMO SE MUESTRA EN LA FIG. C. PASE LA CONTRACHAPA 3" SOBRA LA JUNTA DE LA PIEZA INSTALADA ANTERIOR. GIRE HACE ABAJO HASTA QUE QUEDE SUJETADA LA PIEZA COMO SE MUESTRA EN EL PASO 2.

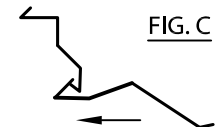
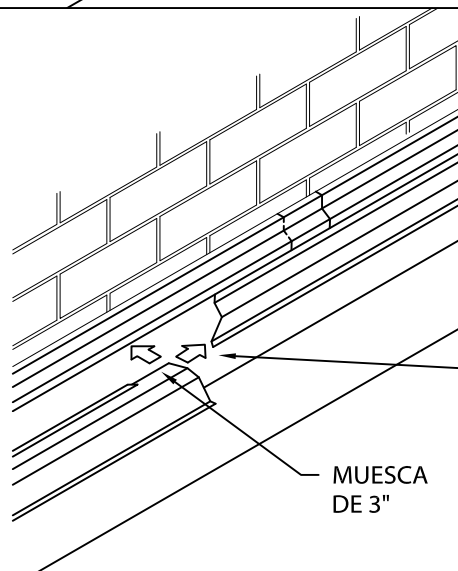

ENGANCHE CONTRACHAPA EN LA REGLETA

DESPUES DE ENGANCHAR, PASE LA CONTRACHAPA 3" SOBRA LA JUNTA DE LA PIEZA INSTALADA ANTERIOR

COUNTER-FLASH 2 PC

REGLET VERSION

INSTALLATION INSTRUCTIONS

SELLADOR
ARQUITECTÓNICO
DE ALTO GRADO

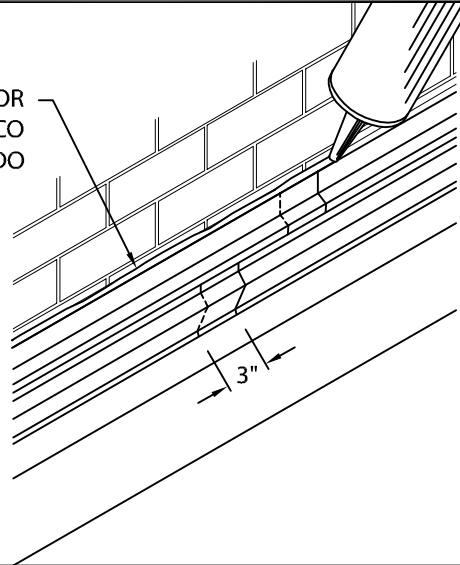

PASO 4 - TERMINACIÓN

APLIQUE UNA TIRA CONTINUA DE SELLADOR
ARQUITECTÓNICO DE ALTO GRADO ENCIMA DE LA
REGLETA RECEPTORA Y EN EL CORTE DE SIERRA PARA
TERMINAR LA INSTALACIÓN.

TYPICAL INSTALLATION

