

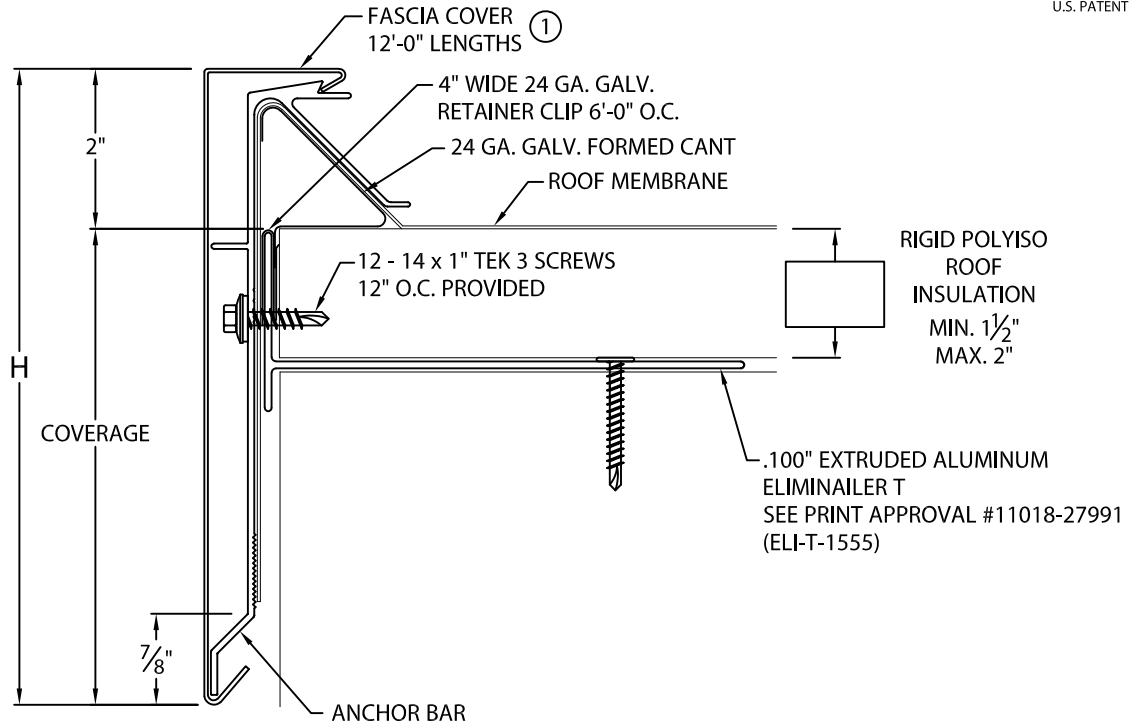

ANCHOR-TITE CANTED FOR USE WITH ELIMINAILER®-T

1.5" ELIMINAILER VERSION
FOR USE WITH METAL DECK

U.S. PATENT # 9,878,023 B1



NOTES:

- ① FASCIA COVER PROVIDED WITH 3½" WIDE SPLICE PLATES.
- ② NOT AVAILABLE IN 24 GA. GALV. STEEL OR .040" ALUMINUM.
- ③ EXTRUDED BAR VARIES IN DESIGN AT LOWER KICK.

ANCHOR-TITE CANTED DIMENSIONS

PRODUCT ID. NO.	H DIM	COVERAGE
<input type="checkbox"/> T-AEFC-55 ③	5½"	3½"
<input type="checkbox"/> T-AEFC-75	7½"	5½"
<input type="checkbox"/> T-AEFC-85	8½"	6½"
<input type="checkbox"/> T-AEFC-100 ②	10"	8"

Fabrication will proceed only after receipt of signed print approval.

Print Approval:

Architect and/or contractor shall verify all dimensions, sizes and quantities. All products to be installed in strict accordance with Metal-Era's printed instructions.

Approved by: _____

Date: _____

CANTED COVER MATERIAL:

- ___ 24 GA. GALVANIZED STEEL COLOR: _____
- ___ 22 GA. GALVANIZED STEEL FINISH: _____
- ___ .040" ALUMINUM
- ___ .050" ALUMINUM
- ___ .063" ALUMINUM
- ___ OTHER _____

QUANTITIES:

- _____ LINEAL FEET 12'-0" LENGTHS
- _____ OUTSIDE MITER(S) @ 90°
- _____ INSIDE MITER(S) @ 90°
- _____ OVERFLOW SCUPPER(S) STYLE ___A___B
- _____ SPILLOUT SCUPPER(S) STYLE ___A___B
- _____ DOWNSPOUT(S) STYLE ___A___B (___x___) DOWNSPOUT SIZE
A: TAPERED 1 1/2" DROP B: FLAT

FOR NON-90 MITERS SEE PRINT APPROVAL #11010-1103

PROJECT:

ARCHITECT:

ROOFING CONTRACTOR:

REPRESENTATIVE/DISTRIBUTOR:

Corporate Offices, Manufacturing
1600 Airport Road; Waukesha, WI 53188
Phone: 800-558-2162
Fax: 800-373-9156
www.metalera.com



DATE: 03/15/18

DRN BY: JJC

CKD BY: SAK

SHT.# ___ OF ___

DWG# 11010-28233

A

ELIMINAILER®-T

FOR USE WITH METAL DECK, 1.5" VERSION

U.S. PATENT # 9,878,023 B1

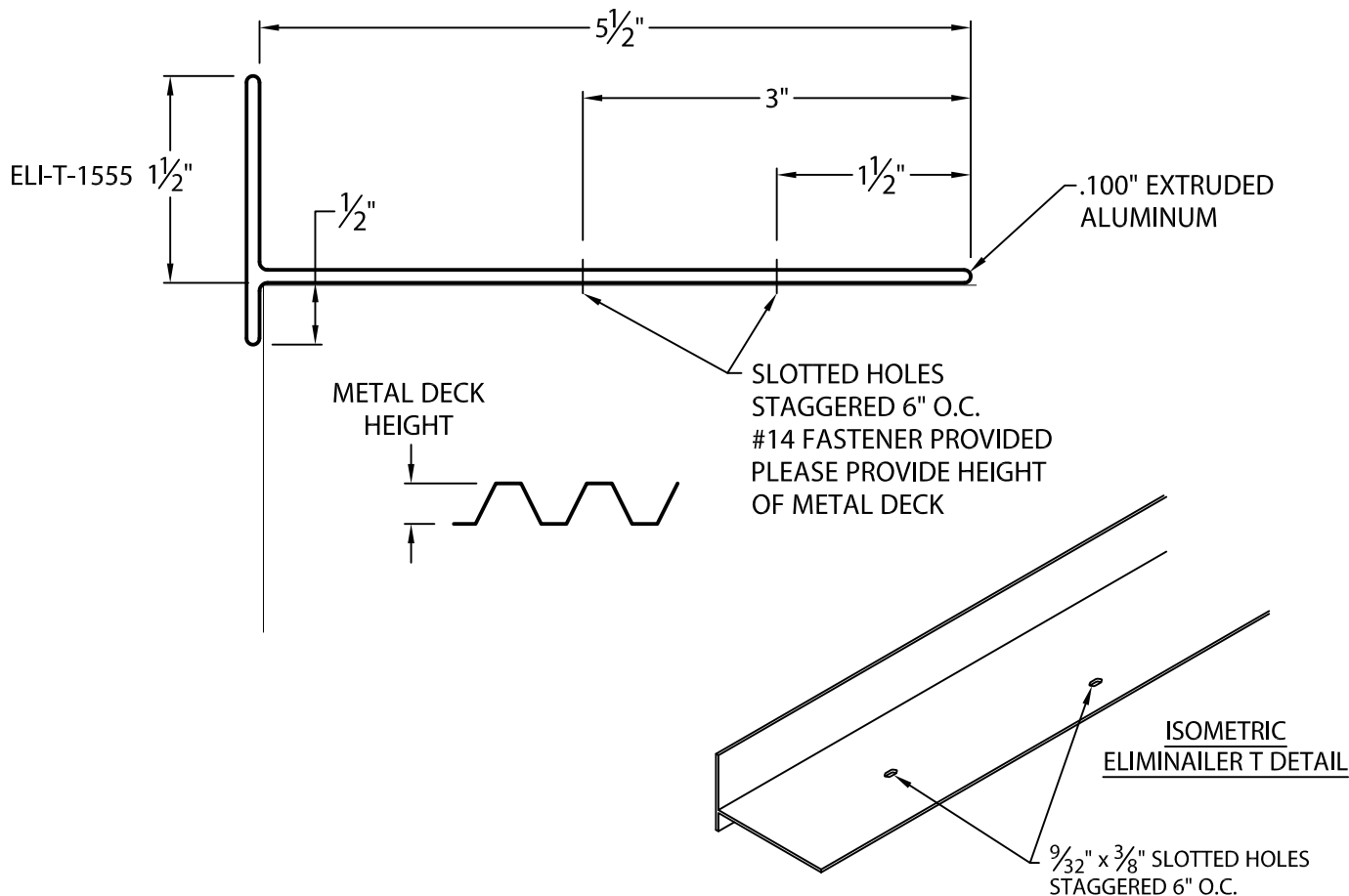

Fabrication will proceed only after receipt of signed print approval.

Print Approval:

Architect and/or contractor shall verify all dimensions, sizes and quantities. All products to be installed in strict accordance with Metal-Era's printed instructions.

Approved by: _____

Date: _____

METAL DECK (22 GA. OR 20 GA. ONLY):

METAL DECK HEIGHT: _____

QUANTITIES:

_____ LINEAL FEET 12'-0" LENGTHS

PROJECT:

ARCHITECT:

ROOFING CONTRACTOR:

REPRESENTATIVE/DISTRIBUTOR:

Corporate Offices, Manufacturing
1600 Airport Road; Waukesha, WI 53188
Phone: 800-558-2162
Fax: 800-373-9156
www.metalera.com



DATE: 04/28/18

DRN BY: JJC

CKD BY: SAK

SHT.# ____ OF ____

DWG# 11018-27991

A